

# ***ProSort PS4.0 Troubleshooting Guide***

## ***Index***

[Initial Setup](#)

[Tail Gate Issues](#)

[Head Gate Issues](#)

[Sluggish Gate Movement](#)

[Sorter not going into Market Mode](#)

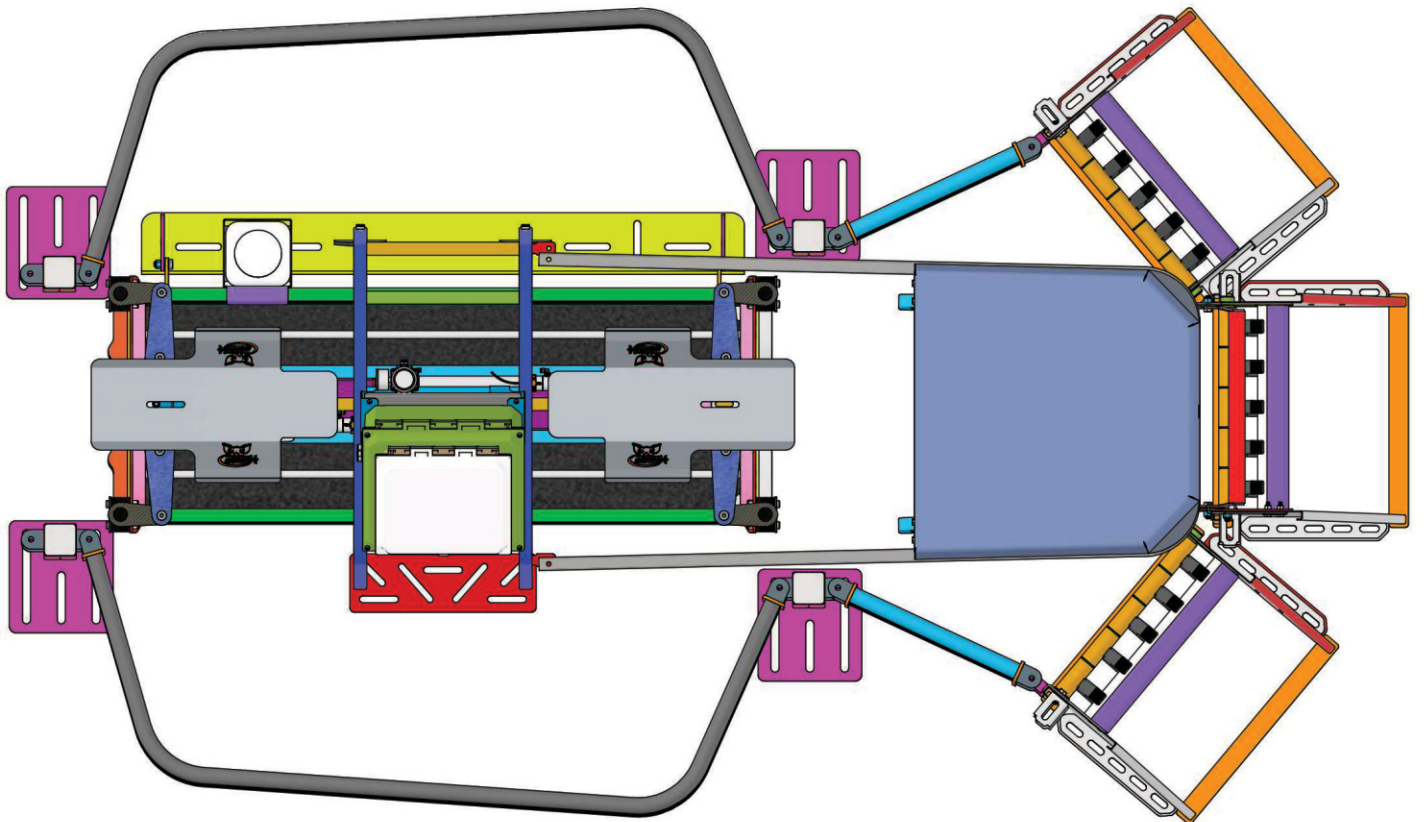
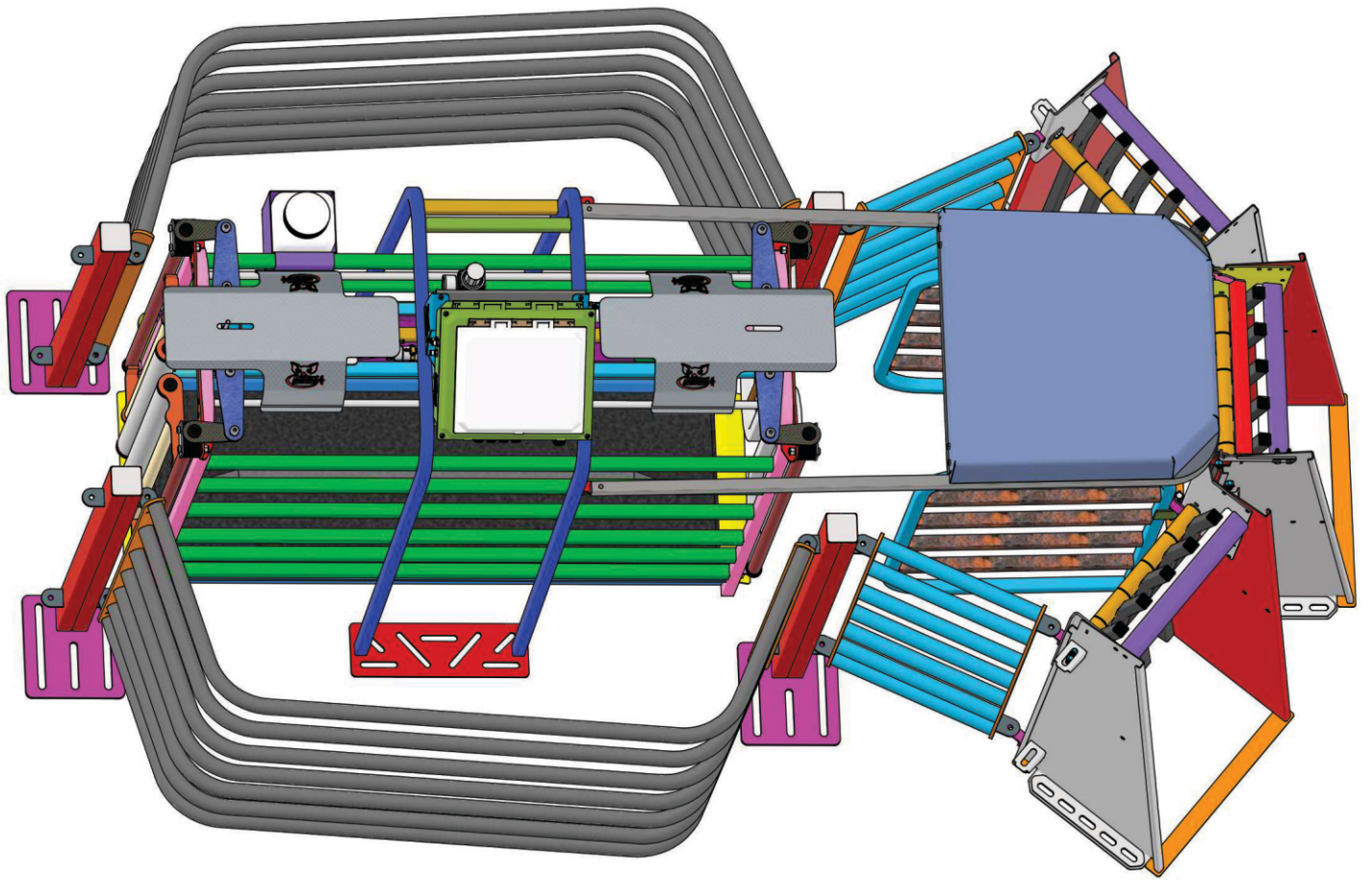

# Initial Sorter Setup

[Index](#)

1: Fasten Sorter Base Plate securely to floor.

2: Fasten opposite side of Arch securely to floor, making sure that the loadcell hanging bolt is straight up and down like a plumb. You might have to push or pull the arch legs when fastening the small base plate.

3: Continue mounting Oneway Gates and Sort Table. Then mount the Sort Gates making sure there is no binding.

4: Tighten up the Threaded Rod above the load cell so that the cage is approximately 3/4 inch off the floor.

5: With NO 120v power supplied, connect all Air Hoses. Connect them so that when you are done that the tail gate and head gates are open, and sort gates are open to the Medium Food Court. (Biggest Pen) That is to ensure that when you loose power to the sorter that the pigs have the biggest pen available to them.

6: Power up Sorter. Wait till powered up.

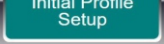
7: From the Main Menu Screen click “Initial Profile Setup”  Change all settings relevant to your needs. On the right side of the screen click all buttons that fit your needs. For instance, if your Light pen is Left, Market pen is Straight, and Medium pen is Right, on the left settings you would click “Light”, on the straight settings you would click “Heavy” and “Market” and on the right you would click “Power Off”, “Default” and “Medium”.

For Two-Way Sort: Set up like above, but select “Medium for your blocked gate, and “Power Off”, “Default” for the “Light” pen.

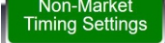
8: From the Main Menu Screen click “Non Market Timing Settings”  Change all settings relevant to your needs. On the Data Cells in the OneWays, look over your food courts and estimate the sizing of your pens to equal 100%. If ProSort Systems designed your pens a good number would be 20% in the Light Pen, 30% in the Heavy Pen, and 50% in the Medium Pen.

For Two-Way Sort: Make sure blocked pen is 0%. The other two remaining pens are generally 50%.

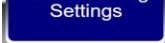
9: From the Main Menu Screen click “Non Market Timing Settings”  Change all settings relevant to your needs. On the Data Cells in the OneWays, look over your food courts and estimate the sizing of your pens to equal 100%. If ProSort Systems designed your pens a good number would be 35% in the Light Pen, and 65% in the Medium Pen.

For Two-Way Sort: Make sure blocked pen is 0%, “Light” pen is 100%.

10: From the Main Menu Screen click “Load Cell Diagnostics”  then click on

“Calibrate”  Follow the instructions.





# Tail Gate

## Opens and Closes

1: Incorrect Tail Gate Close Duration setting

1: Go into , “Tail Gate Close Duration” should be 10+ seconds.

2: Bad Tail Gate cylinder sensor.

2: From the Main Menu with all the Icon Menu Buttons, press the  then the  This should bring you into the Maintenance Screen. Enable the , then press the , the  light should turn green when the gate is closed. If it does not, the Tail Gate cylinder sensor is out of adjustment or bad. To adjust loosen the clamp that fastens the sensor to the cylinder and slide the sensor back and forth till sensor lights up.

Tail Gate sensor is bad when:

It doesn't light up with the above instructions,

If Head Gate is open, Tail Gate opens-closes in time to “animal Chaser Delay”

If Head Gate is closed, Tail Gate opens-closes in time to “Tail Gate Close Duration”

## Doesn't Closes Quick Enough

1: Go into , Change the “Base Weight Calculation %” to a lower number.





## Closes prematurely, when scaled pig should be released

1: Go into , Check “Chaser Pig Delay”. Default is 20 seconds.

# Head Gate

## Opens and Closes

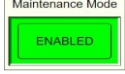
### 1: Bad Head Gate Cylinder Sensor

1: From the Main Menu with all the Icon Menu Buttons, press the  then the . This should bring you into the Maintenance Screen. Enable the Maintenance Mode , then press the , the  light should turn green when the Head Gate is closed. If it does not, the Head Gate sensor is out of adjustment or bad. To adjust loosen the clamp that fastens the sensor to the cylinder and slide the sensor back and forth till sensor lights up.

# Sluggish Gate Movement

## Gates move sluggishly

1: Not enough air pressure

1: Set the air regulator to 50 PSI

2: Not enough air flow.

2: Watch pressure gauge on air regulator, when pressure really fluctuates when a gate moves, there is not enough air flow to sorter.

3: Kinks in air hoses.

3: Visually check all hoses for kinks.

4: Mechanical binding.

4: Check gate if movement is free.

# Sorter not going into Market Mode

1: From Main Menu click Home Button  then Maint.  In the top right corner make sure the  is Red and shows "Disabled"

2. In "Training Mode", on the screen with the main sorter graphics, make sure the arrows at the one ways are Blue, and not Grey. Touch arrows to change state. If arrow is Grey, this exit gate is disabled.

3. Make sure the "Population" closely matches the animal units in the barn. You can find the setting on the main sorter graphic page, on the top-left corner.

4. Power cycle the control.